



# 2010 National Scout Jamboree™ Design Your Own Council Shoulder Insignia

Council \_\_\_\_\_ Address \_\_\_\_\_

City \_\_\_\_\_ State \_\_\_\_\_ Zip \_\_\_\_\_

Quantity Needed \_\_\_\_\_ Date Needed \_\_\_\_\_ Email \_\_\_\_\_ Phone \_\_\_\_\_

Scout Executive or Jamboree Coordinator Signature \_\_\_\_\_

**YES!** I want a color proof to approve with my price quote. I understand that \$150 will be charged to my account if an order is not placed within 30 days.

### **HERE'S WHAT YOU DO!**

**1 Sketch your design in the blank area of the shape you choose, or e-mail your art to [custom.design@scouting.org](mailto:custom.design@scouting.org).** Shown at right are the defined shapes for use. Your sketch must show your design exactly as you want it produced. If you choose to e-mail your design, please make certain it is in a JPG format.

**2 Indicate the colors in your design.**

**3 Indicate if you want a color proof of your design with your price quote.**

**4 Complete the order form, indicating the quantity and date needed.** Minimum quantity is 48. Additional quantities must be ordered in increments of 48. All orders are subject to a 10 percent over/under-run. Remember to include your artwork with order

**ORDER EARLY TO AVOID DELAY!** Standard delivery is four (4) weeks once an order is placed with approved artwork.

### **IMPORTANT**

Your design must include your council name and one of the following:

- Boy Scouts of America
- BSA
- BSA universal emblem or fleur-de-lis

If using the BSA 100th Anniversary logo in your design, see approved templates to the right.

Designs are subject to national office approval. Shoulder insignia that do not conform to national standards will not be approved and may not be worn on the uniform unless modified to meet the national standards.

*The 2010 National Scout Jamboree logo is a trademark of the Boy Scouts of America and may NOT be used on JSP's.*

*Any local council desiring to incorporate a commercial, third-party mark, word or phrase into its 2010 Jamboree CSP must have both written permission from the commercial mark owner and the authorization of the Boy Scouts of America National Council. For more information visit [www.bsajamboree.org](http://www.bsajamboree.org)*

Send your design to:

**BOY SCOUTS OF AMERICA, SUPPLY GROUP**  
2109 Westinghouse Blvd.  
P.O. Box 7143  
Charlotte, NC 28241-7143  
800-323-0732 • FAX 704-583-3146  
[custom.design@scouting.org](mailto:custom.design@scouting.org)

## Sample Patch Templates **Shoulder Insignia**

Maximum CSP height to allow for Custom Unit Numerals is 2"  
These images are not to scale.

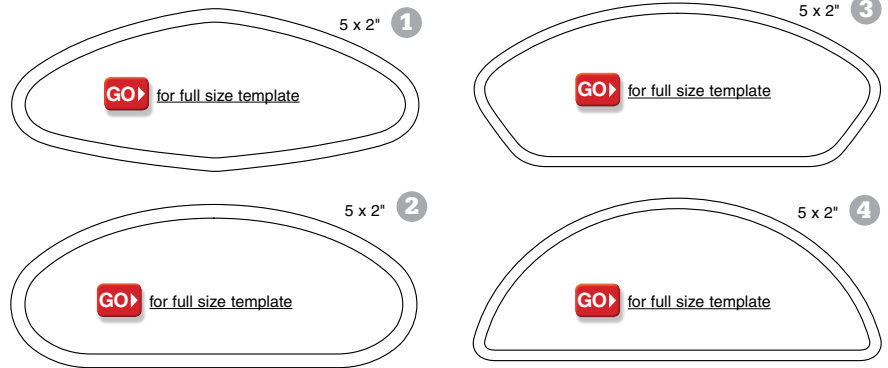

## Sample Patch Templates **Shoulder Insignia** 2010 BSA 100th Anniversary Logo

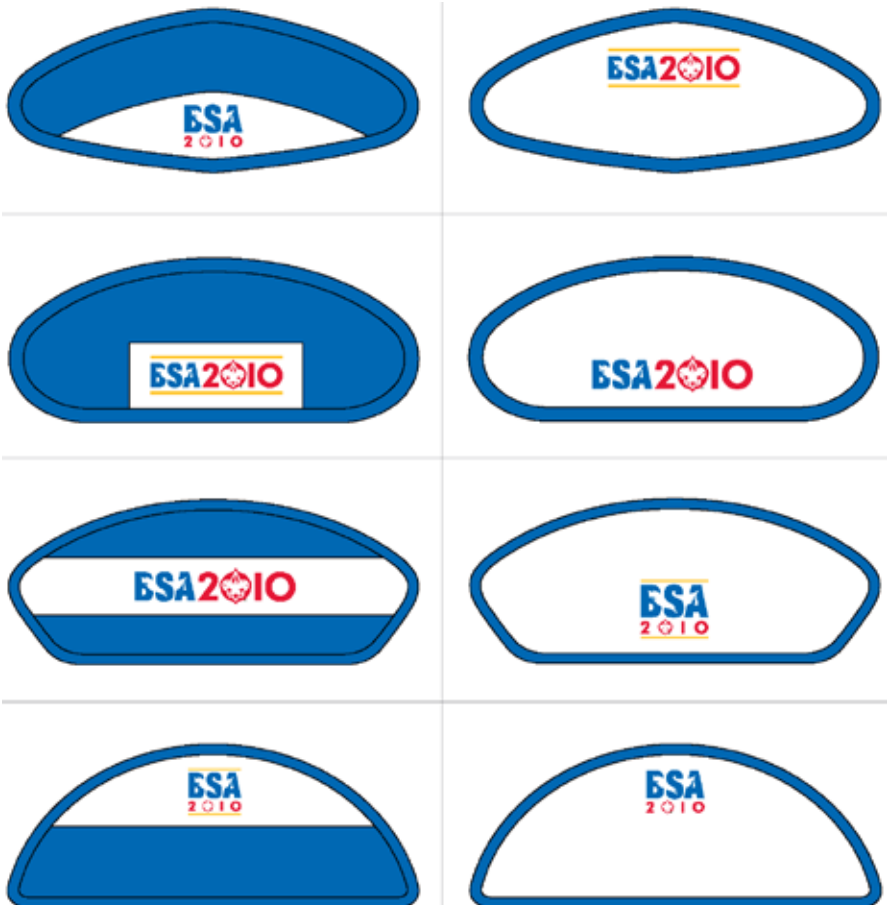

# Sample Patch Templates **Shoulder Insignia** 2010 BSA 100th Anniversary Logo

For position only. These images are not to scale.



# Sample Patch Templates **Shoulder Insignia**

NOTE: To print correct scale, make sure your printer preferences are set to 100%

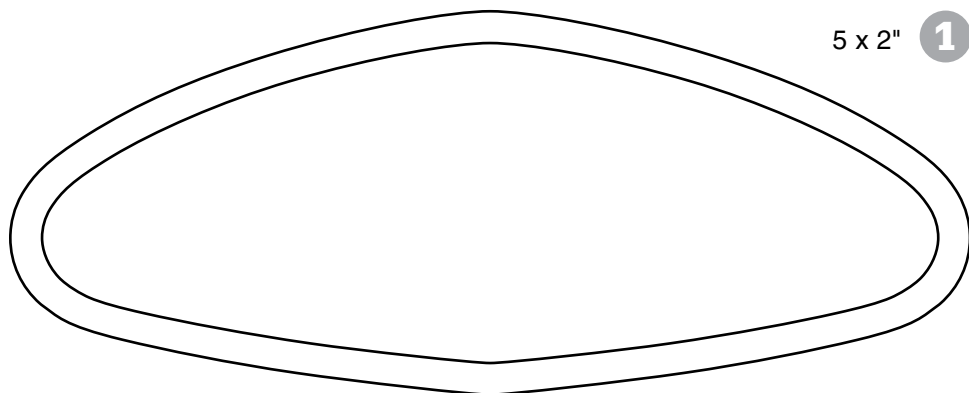
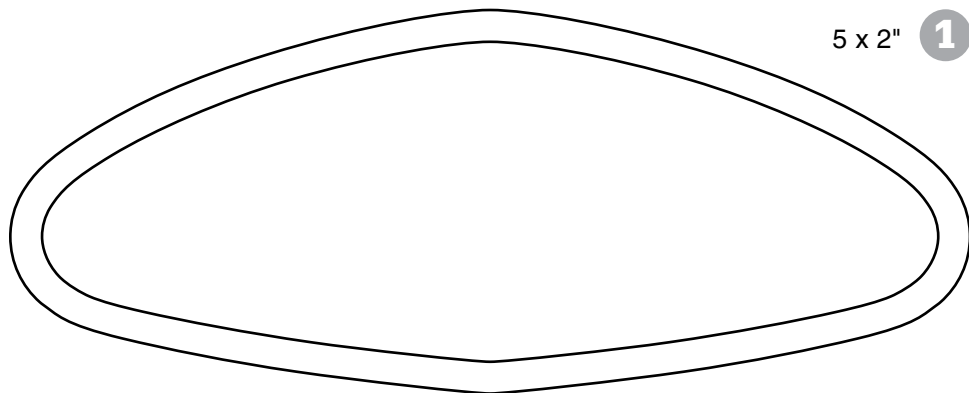
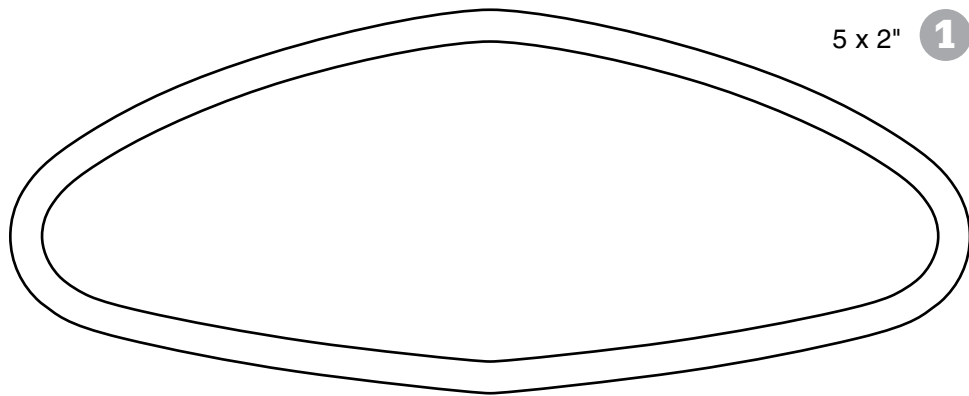
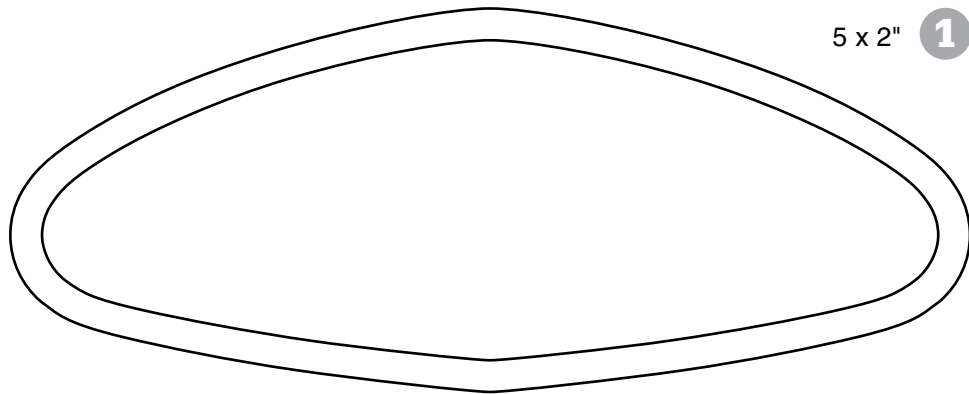

# Sample Patch Templates **Shoulder Insignia**

NOTE: To print correct scale, make sure your printer preferences are set to 100%

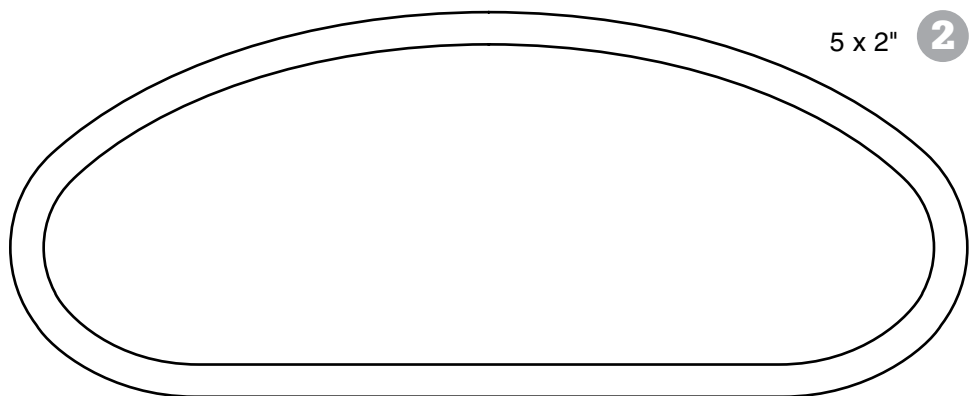
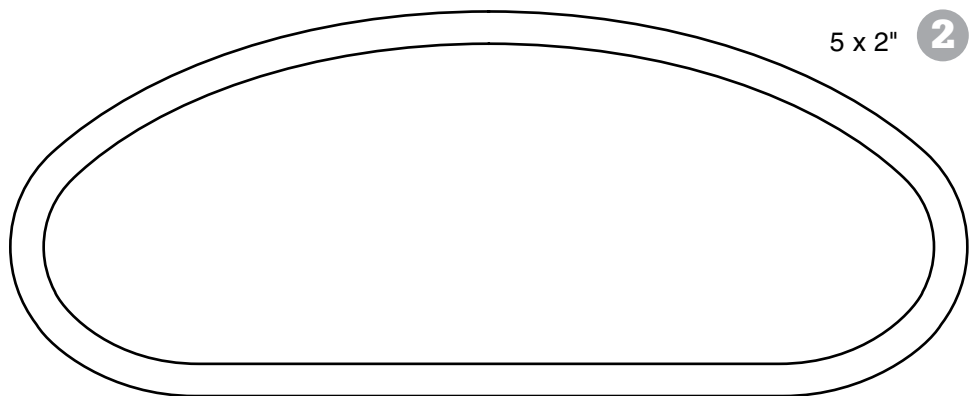
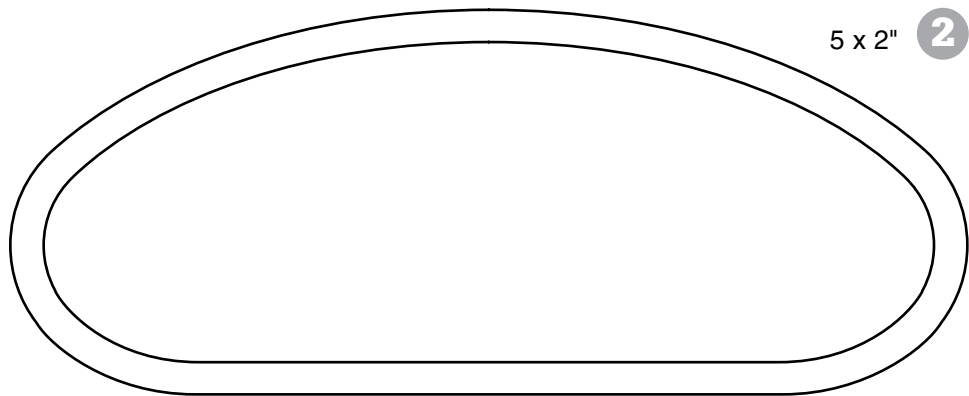
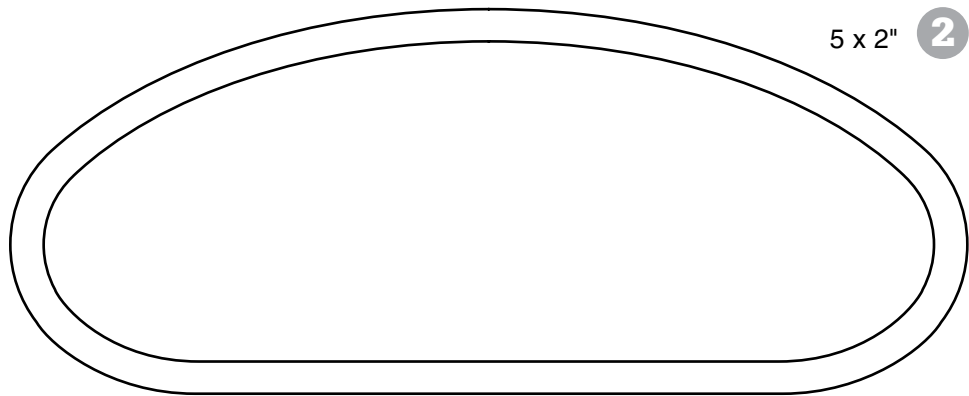

# Sample Patch Templates **Shoulder Insignia**

NOTE: To print correct scale, make sure your printer preferences are set to 100%

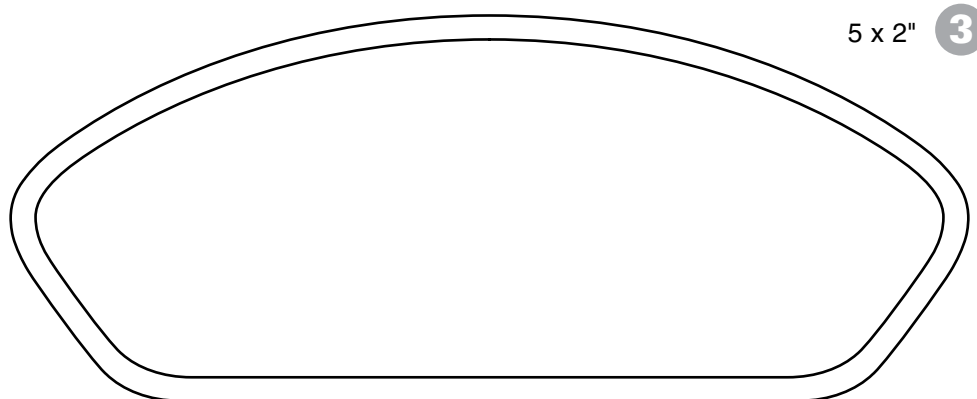
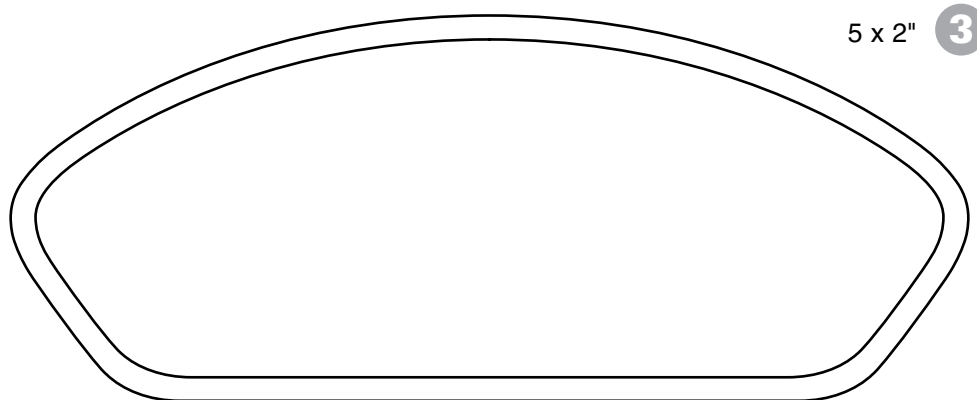
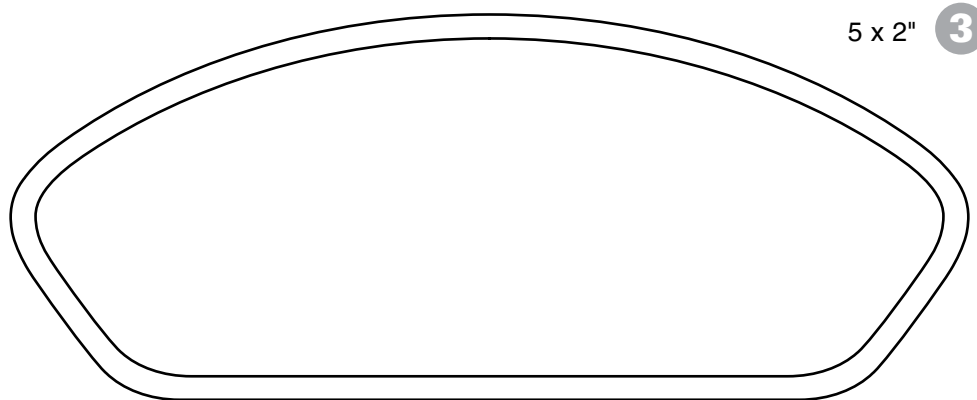
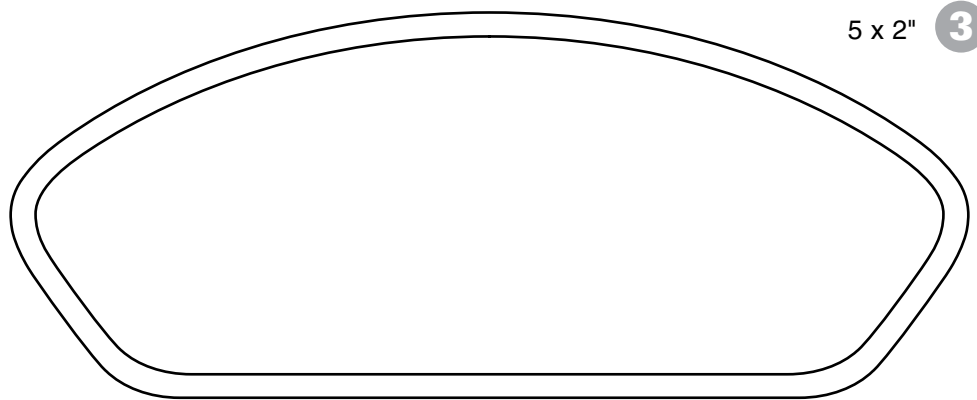

# Sample Patch Templates **Shoulder Insignia**

NOTE: To print correct scale, make sure your printer preferences are set to 100%

